

MADE IN GERMANY
DEUTSCHES
WERKZEUG

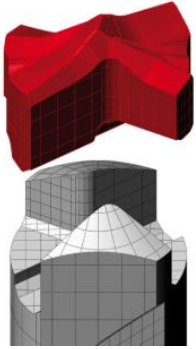

QUALITÄTSBOHRWERKZEUGE
KEIL Werkzeugfabrik

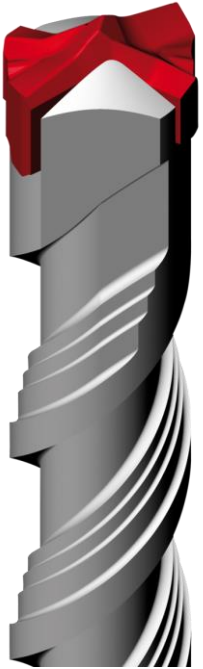

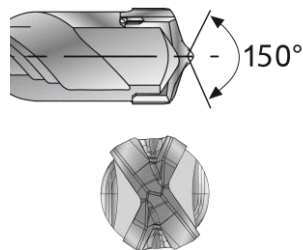
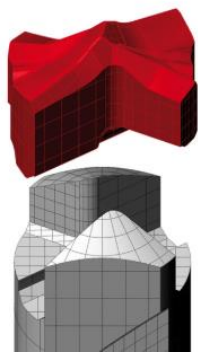
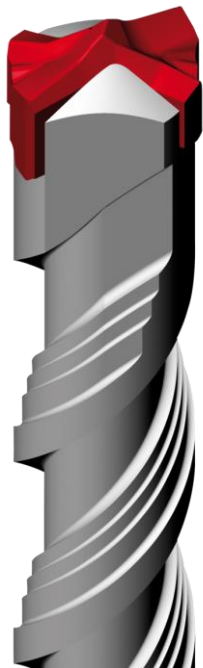

SDS Plus svrdla za armirani beton

- *TURBOHEAD X PRO glava s inovativnim konceptom 4 vrha*
- *MS 5 spirala s ojačanom jezgrom*
- *Otporno na betonsku armaturu, te kroz istu prolazi bez problema*
- *Znatno manje trenje*

QUALITÄTSBOHRWERKZEUGE

KEIL Werkzeugfabrik



Kataloški broj	Naziv artikla	Dimenzija	J.mj.	VPC/Kn	MPC/Kn	Narudžba / kom
		Svrdla Promjera 5,0 mm				
A1.251.050.110	KEIL Svrdlo SDS Plus TURBOHEAD X PRO	5,0x50x110 mm	kom	28,00 kn	35,00 kn	
A1.251.050.160	KEIL Svrdlo SDS Plus TURBOHEAD X PRO	5,0x100x160 mm	kom	32,50 kn	40,62 kn	
A1.251.050.210	KEIL Svrdlo SDS Plus TURBOHEAD X PRO	5,0x150x210 mm	kom	42,90 kn	53,62 kn	
A1.251.050.260	KEIL Svrdlo SDS Plus TURBOHEAD X PRO	5,0x200x260 mm	kom	57,95 kn	72,43 kn	
		Svrdla Promjera 5,5 mm				
A1.251.055.110	KEIL Svrdlo SDS Plus TURBOHEAD X PRO	5,5x50x110 mm	kom	31,20 kn	39,00 kn	
A1.251.055.160	KEIL Svrdlo SDS Plus TURBOHEAD X PRO	5,5x100x160 mm	kom	36,60 kn	45,75 kn	
A1.251.055.210	KEIL Svrdlo SDS Plus TURBOHEAD X PRO	5,5x150x210 mm	kom	45,90 kn	57,37 kn	
A1.251.055.260	KEIL Svrdlo SDS Plus TURBOHEAD X PRO	5,5x200x260 mm	kom	60,80 kn	76,00 kn	
		Svrdla Promjera 6,0 mm				
A1.251.060.110	KEIL Svrdlo SDS Plus TURBOHEAD X PRO	6,0x50x110 mm	kom	26,80 kn	33,50 kn	
A1.251.060.160	KEIL Svrdlo SDS Plus TURBOHEAD X PRO	6,0x100x160 mm	kom	30,00 kn	37,50 kn	
A1.251.060.210	KEIL Svrdlo SDS Plus TURBOHEAD X PRO	6,0x150x210 mm	kom	44,10 kn	55,12 kn	
A1.251.060.260	KEIL Svrdlo SDS Plus TURBOHEAD X PRO	6,0x200x260 mm	kom	55,50 kn	69,37 kn	
		Svrdla Promjera 6,5 mm				
A1.251.065.160	KEIL Svrdlo SDS Plus TURBOHEAD X PRO	6,5x110x160 mm	kom	37,40 kn	46,75 kn	
A1.251.065.210	KEIL Svrdlo SDS Plus TURBOHEAD X PRO	6,5x160x210 mm	kom	53,60 kn	67,00 kn	
A1.251.065.260	KEIL Svrdlo SDS Plus TURBOHEAD X PRO	6,5x210x260 mm	kom	67,60 kn	84,50 kn	
A1.251.065.310	KEIL Svrdlo SDS Plus TURBOHEAD X PRO	6,5x250x310 mm	kom	76,90 kn	96,12 kn	

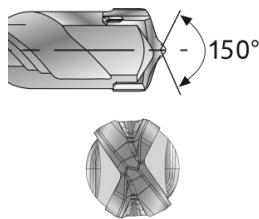
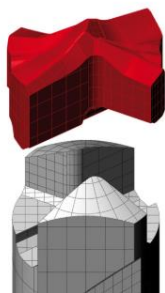
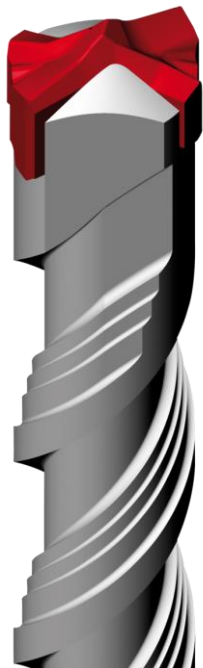

SDS Plus svrdla za armirani beton

- *TURBOHEAD X PRO glava s inovativnim konceptom 4 vrha*
- *MS 5 spirala s ojačanom jezgrom*
- *Otporno na betonsku armaturu, te kroz istu prolazi bez problema*
- *Znatno manje trenje*

QUALITÄTSBOHRWERKZEUGE

KEIL Werkzeugfabrik



Katalogski broj	Naziv artikla	Dimenzija	J.mj.	VPC/Kn	MPC/Kn	Narudžba / kom
		Svrdla Promjera 8 mm				
A1.251.080.110	KEIL Svrdlo SDS Plus TURBOHEAD X PRO	8,0x50x110 mm	kom	33,50 kn	41,87 kn	
A1.251.080.160	KEIL Svrdlo SDS Plus TURBOHEAD X PRO	8,0x100x160 mm	kom	36,50 kn	45,62 kn	
A1.251.080.210	KEIL Svrdlo SDS Plus TURBOHEAD X PRO	8,0x150x210 mm	kom	45,70 kn	57,12 kn	
A1.251.080.260	KEIL Svrdlo SDS Plus TURBOHEAD X PRO	8,0x200x260 mm	kom	53,70 kn	67,12 kn	
A1.251.080.310	KEIL Svrdlo SDS Plus TURBOHEAD X PRO	8,0x250x310 mm	kom	74,20 kn	92,75 kn	
A1.251.080.360	KEIL Svrdlo SDS Plus TURBOHEAD X PRO	8,0x300x360 mm	kom	90,90 kn	113,62 kn	
A1.251.080.460	KEIL Svrdlo SDS Plus TURBOHEAD X PRO	8,0x410x460 mm	kom	134,20 kn	167,75 kn	
		Svrdla Promjera 10 mm				
A1.251.100.160	KEIL Svrdlo SDS Plus TURBOHEAD X PRO	10,0x100x160 mm	kom	44,45 kn	55,56 kn	
A1.251.100.210	KEIL Svrdlo SDS Plus TURBOHEAD X PRO	10,0x150x210 mm	kom	53,80 kn	67,25 kn	
A1.251.100.260	KEIL Svrdlo SDS Plus TURBOHEAD X PRO	10,0x200x260 mm	kom	62,50 kn	78,12 kn	
A1.251.100.310	KEIL Svrdlo SDS Plus TURBOHEAD X PRO	10,0x250x310 mm	kom	78,65 kn	98,31 kn	
A1.251.100.360	KEIL Svrdlo SDS Plus TURBOHEAD X PRO	10,0x310x360 mm	kom	96,70 kn	120,87 kn	
A1.251.100.460	KEIL Svrdlo SDS Plus TURBOHEAD X PRO	10,0x400x460 mm	kom	132,25 kn	165,31 kn	
		Svrdla Promjera 12 mm				
A1.251.120.160	KEIL Svrdlo SDS Plus TURBOHEAD X PRO	12,0x100x160 mm	kom	50,20 kn	62,75 kn	
A1.251.120.210	KEIL Svrdlo SDS Plus TURBOHEAD X PRO	12,0x150x210 mm	kom	59,15 kn	73,93 kn	
A1.251.120.260	KEIL Svrdlo SDS Plus TURBOHEAD X PRO	12,0x200x260 mm	kom	74,12 kn	92,65 kn	
A1.251.120.310	KEIL Svrdlo SDS Plus TURBOHEAD X PRO	12,0x250x310 mm	kom	90,50 kn	113,12 kn	
A1.251.120.450	KEIL Svrdlo SDS Plus TURBOHEAD X PRO	12,0x400x450 mm	kom	141,50 kn	176,87 kn	

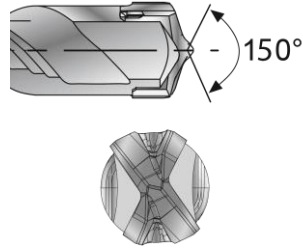
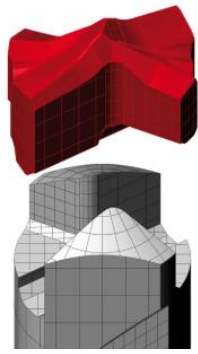
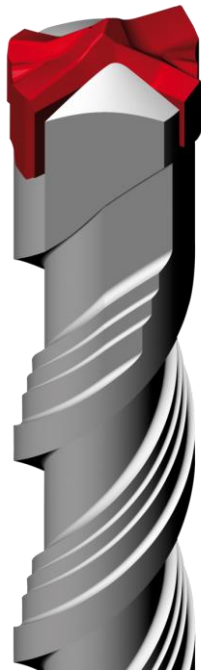

SDS Plus svrdla za armirani beton

- *TURBOHEAD X PRO glava s inovativnim konceptom 4 vrha*
- *MS 5 spirala s ojačanom jezgrom*
- *Otporno na betonsku armaturu, te kroz istu prolazi bez problema*
- *Znatno manje trenje*

QUALITÄTSBOHRWERKZEUGE

KEIL Werkzeugfabrik



Kataloški broj	Naziv artikla	Dimenzija	J.mj.	VPC/Kn	MPC/Kn	Narudžba / kom
		Svrdla Promjera 14 mm				
A1.251.140.160	KEIL Svrdlo SDS Plus TURBOHEAD X PRO	14,0x100x160 mm	kom	67,70 kn	84,62 kn	
A1.251.140.210	KEIL Svrdlo SDS Plus TURBOHEAD X PRO	14,0x150x210mm	kom	77,90 kn	97,37 kn	
A1.251.140.260	KEIL Svrdlo SDS Plus TURBOHEAD X PRO	14,0x200x260mm	kom	86,25 kn	107,81 kn	
A1.251.140.310	KEIL Svrdlo SDS Plus TURBOHEAD X PRO	14,0x250x310 mm	kom	104,85 kn	131,06 kn	
A1.251.140.450	KEIL Svrdlo SDS Plus TURBOHEAD X PRO	14,0x400x450 mm	kom	152,29 kn	190,36 kn	
		Svrdla Promjera 16 mm				
A1.251.160.160	KEIL Svrdlo SDS Plus TURBOHEAD X PRO	16,0x100x160 mm	kom	92,65 kn	115,81 kn	
A1.251.160.210	KEIL Svrdlo SDS Plus TURBOHEAD X PRO	16,0x150x210 mm	kom	104,05 kn	130,06 kn	
A1.251.160.260	KEIL Svrdlo SDS Plus TURBOHEAD X PRO	16,0x200x260 mm	kom	112,60 kn	140,75 kn	
A1.251.160.450	KEIL Svrdlo SDS Plus TURBOHEAD X PRO	16,0x400x450 mm	kom	166,20 kn	207,75 kn	
		Svrdla Promjera 18 mm				
A1.251.180.250	KEIL Svrdlo SDS Plus TURBOHEAD X PRO	18,0x200x250 mm	kom	166,90	208,62 kn	
A1.251.180.450	KEIL Svrdlo SDS Plus TURBOHEAD X PRO	18,0x400x450 mm	kom	206,50 kn	258,12 kn	
		Svrdla Promjera 20 mm				
A1.251.200.250	KEIL Svrdlo SDS Plus TURBOHEAD X PRO	251/20,0x200x250 mm	kom	203,50 kn	254,37 kn	
A1.251.200.450	KEIL Svrdlo SDS Plus TURBOHEAD X PRO	251/20,0x400x450 mm	kom	250,30 kn	254,37 kn	

SDS Plus krune za armirani beton / M 16 - komplet

QUALITÄTSBOHRWERKZEUGE

KEIL Werkzeugfabrik

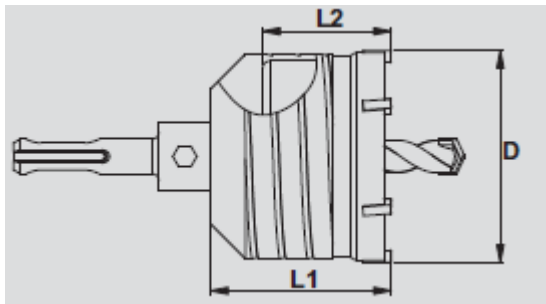

- Krune sa 6 karbidnih ojačanih pločica
- Sa internim M 16 navojem
- SDS Plus držač s centralnim probojnim svrdlom
- Izrađeno od Crom-molibden-nikal čelika s ojačanom debelom stjenkom



Kataloški broj	Naziv artikla	Dimenzija (promjer)	J.mj.	VPC/Kn	MPC/Kn	Narudžba / kom
A1.711.713.050	Kruna za bušenje SDS Plus prihvatom	50,0x60x80 mm	kom	356,15 kn	445,18 kn	
A1.711.713.065	Kruna za bušenje SDS Plus prihvatom	65,0x52x72 mm	kom	368,95 kn	461,18 kn	
A1.711.713.068	Kruna za bušenje SDS Plus prihvatom	68,0x52x72 mm	kom	384,50 kn	480,62 kn	
A1.711.713.080	Kruna za bušenje SDS Plus prihvatom	80,0x60x80 mm	kom	432,65 kn	540,81 kn	



SDS Plus krune za armirani beton / M 16

- Krune sa 6 karbidnih ojačanih pločica
- Sa internim M 16 navojem
- SDS Plus držač s centralnim probojnim svrdlom
- Izrađeno od Crom-molibden-nikal čelika s ojačanom debelom stjenkom

QUALITÄTSBOHRWERKZEUGE

KEIL Werkzeugfabrik



Kataloški broj	Naziv artikla	Dimenzija (promjer)	J.mj.	VPC/Kn	MPC/Kn	Narudžba / kom
A1.711.000.055	Kruna za bušenje SDS Plus prihvatom	55,0x52x72mm	kom	250,25 kn	312,81 kn	
A1.711.000.060	Kruna za bušenje SDS Plus prihvatom	60,0x52x72mm	kom	252,30 kn	312,81 kn	
A1.711.000.090	Kruna za bušenje SDS Plus prihvatom	90,0x60x80 mm	kom	412,65 kn	515,81 kn	
A1.711.000.100	Kruna za bušenje SDS Plus prihvatom	100,0x60x80 mm	kom	670,30 kn	837,87 kn	



SDS Plus adapteri za krune

- Adapter s SDS Plus prihvatom i HILTI TE-C
- M 16 navoj

Kataloški broj	Naziv artikla	Dužina	J.mj.	VPC/Kn	MPC/Kn	Narudžba / kom
A1.713.080.120	SDS Plus adapter za krune HILTI TE-C	105 mm / navoj M 16	kom	109,29 kn	136,61 kn	
A1.713.200.120	SDS Plus adapter za krune HILTI TE-C	200 mm / navoj M 16	kom	178,56 kn	223,20 kn	
A1.713.300.120	SDS Plus adapter za krune HILTI TE-C	350 mm / navoj M 16	kom	232,67 kn	290,83 kn	

SDS Max svrdla za armirani beton

QUALITÄTSBOHRWERKZEUGE

KEIL Werkzeugfabrik

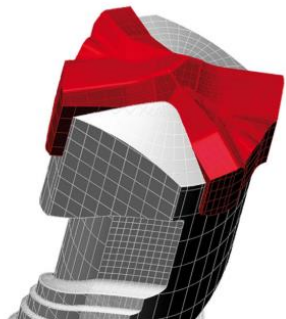

- *Izrađeno od krom-nikal-molibden čelika, induktivno žaren i kaljen*
- *Specijalno dizajnirana glava za bolje centriranje, brži proces bušenja*
- *Geometrija s 4 oštrice štiti od oštećenja prilikom udara na željezo*



Kataloški broj	Naziv artikla	J.mj.	VPC/Kn	MPC/Kn	Narudžba / kom
A1.270.160.341	KEIL Svrdlo SDS Max 16 x 200 x 340 W2 TURBOHEAD X PRO	kom	278,50 kn	348,12 kn	
A1.270.180.341	KEIL Svrdlo SDS Max 18 x 200 x 340 W2 TURBOHEAD X PRO	kom	287,35 kn	359,18 kn	
A1.270.180.541	KEIL Svrdlo SDS Max 18 x 400 x 540 W2 TURBOHEAD X PRO	kom	341,30 kn	426,62 kn	
A1.270.200.321	KEIL Svrdlo SDS Max 20 x 200 x 320 W2 TURBOHEAD X PRO	kom	292,30 kn	365,37 kn	
A1.270.200.521	KEIL Svrdlo SDS Max 20 x 400 x 520 W2 TURBOHEAD X PRO	kom	351,60 kn	439,50 kn	
A1.270.220.520	KEIL Svrdlo SDS Max 22 x 400 x 520 W2 TURBOKEIL X PRO	kom	369,80 kn	462,25 kn	
A1.270.240.320	KEIL Svrdlo SDS Max 24 x 200 x 320 W2 TURBOKEIL X PRO	kom	359,29 kn	449,11 kn	
A1.270.250.520	KEIL Svrdlo SDS Max 25 x 400 x 520 W2 TURBOKEIL X PRO	kom	410,30 kn	512,87 kn	
A1.270.280.570	KEIL Svrdlo SDS Max 28 x 450 x 570 W2 TURBOKEIL X PRO	kom	464,25 kn	580,31 kn	
A1.270.300.570	KEIL Svrdlo SDS Max 30 x 450 x 570 W2 TURBOKEIL X PRO	kom	505,30 kn	631,62 kn	
A1.270.320.570	KEIL Svrdlo SDS Max 32 x 450 x 570 W2 TURBOKEIL X PRO	kom	564,30 kn	705,37 kn	
A1.270.350.570	KEIL Svrdlo SDS Max 35 x 450 x 570 W2 TURBOKEIL X PRO	kom	657,25 kn	821,56 kn	

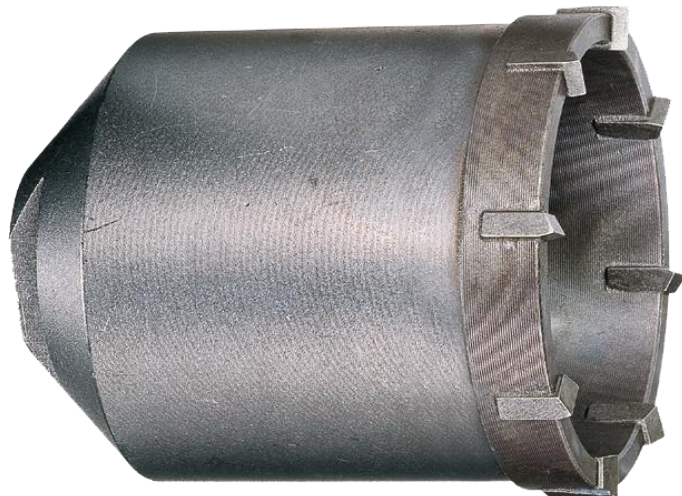

Hammerbohrkrone

SDS Max krune za armirani beton

- Krune su izrađene od visokokvalitetnog Crom-nikal-molibden čelika
- Visokotemperaturno vakuumsko lemljenje na 1.120 °C
- Karbidi izuzetno otporni na trošenje
- 2 faze specijalne visoko temperaturne obrade

QUALITÄTSBOHRWERKZEUGE

KEIL Werkzeugfabrik



Kataloški broj	Naziv artikla	Dimenzija (promjer)	J.mj.	VPC/Kn	MPC/Kn	Narudžba / kom
A1.259.700.040	Kruna za bušenje SDS Max prihvat	40,0x75x100 mm	kom	538,50 kn	673,12 kn	
A1.259.700.050	Kruna za bušenje SDS Max prihvat	50,0x75x100 mm	kom	600,25 kn	750,31 kn	
A1.259.700.060	Kruna za bušenje SDS Max prihvat	60,0x75x100 mm	kom	688,25 kn	860,31 kn	
A1.259.700.065	Kruna za bušenje SDS Max prihvat	65,0x75x100 mm	kom	714,29 kn	892,86 kn	
A1.259.700.080	Kruna za bušenje SDS Max prihvat	80,0x75x100 mm	kom	848,25 kn	1.060,31 kn	
A1.259.700.090	Kruna za bušenje SDS Max prihvat	90,0x75x100 mm	kom	978,29 kn	1.222,86 kn	
A1.259.700.100	Kruna za bušenje SDS Max prihvat	100,0x75x100 mm	kom	1.120,30 kn	1.400,37 kn	
A1.259.700.110	Kruna za bušenje SDS Max prihvat	110,0x75x100 mm	kom	1.178,36 kn	1.472,95 kn	
A1.259.700.125	Kruna za bušenje SDS Max prihvat	125,0x75x100 mm	kom	1.684,30 kn	2.105,37 kn	

SDS Max adapteri za krune s RATIO navojem

QUALITÄTSBOHRWERKZEUGE

KEIL Werkzeugfabrik



- Adapteri s SDS Max prihvatom
- Čvrsti, napravljeni za teške uvjete rada za HILTI TE-Y

Pakiranje

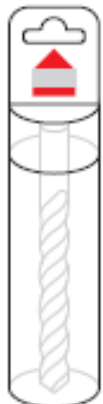

Kataloški broj	Naziv artikla	Dimenzija (dužina)	J.mj.	VPC/Kn	MPC/Kn	Narudžba / kom
A1.259.150.000	SDS Max adapter za HILTI TE-Y	190 mm	kom	360,36 kn	450,45 kn	
A1.259.150.400	SDS Max adapter za HILTI TE-Y	400 mm	kom	494,36 kn	617,95 kn	

Centralno probojno svrdlo s RATIO navojem za SDS Max krune



Kataloški broj	Naziv artikla	Dimenzija (dužina)	J.mj.	VPC/Kn	MPC/Kn	Narudžba / kom
A1.259.120.155	Centralno probojno svrdlo RATIO	12 x 155 mm	kom	155,20 kn	194,00 kn	

SDS Plus špica i dlijeto

QUALITÄTSBOHRWERKZEUGE

KEIL Werkzeugfabrik

Kataloški broj	Naziv artikla	J.mj.	VPC/Kn	MPC/kn	Narudžba /kom
502000251	KEIL Špica SDS Plus 273 / 250 mm za HILTI TE-C	kom	47,20 kn	59,00 kn	



502120250	KEIL Dlijeto SDS Plus 274 / 20 x 250 mm za HILTI TE-C	kom	47,20 kn	59,00 kn	
-----------	---	-----	----------	----------	--



SDS Max Špice i dlijeta

Kataloški broj	Naziv artikla	J.mj.	VPC/Kn	MPC/Kn	Narudžba /kom
503000400	KEIL Špica SDS Max 273 / 400 mm za HILTI TE-Y	kom	76,00 kn	95,00 kn	



503125400	KEIL Dlijeto SDS-MAX 274 / 25 x 400 mm za HILTI TE-Y	kom	76,00 kn	95,00 kn	
-----------	--	-----	----------	----------	--



503250400	KEIL Dlijeto SDS-MAX 275 / 50 x 400 mm za HILTI TE-Y	kom	155,00 kn	193,75 kn	
-----------	--	-----	-----------	-----------	--





SDS Max Probojna svrdla

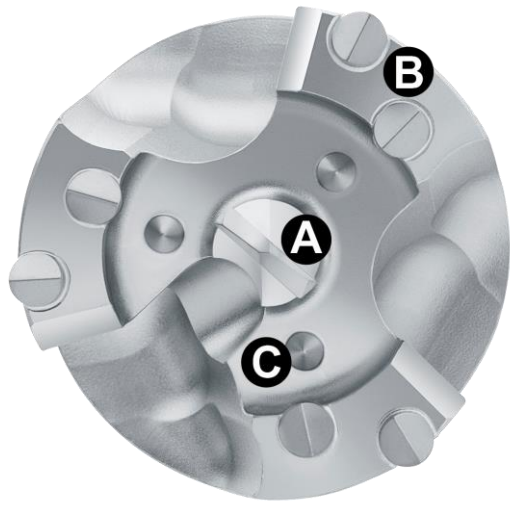

Prednosti glave probojnog svrdla

- Čvrsta konstrukcija u jednom komadu
- Zaštićeno od korozije
- Prihvat za SDS Max i HILTI TE-Y prihvate
- A – točno mjesto bušenja zahvaljujući integriranom centralnom probojnom svrdlu
- B – brzo bušenje i sječenje zbog glave u obliku dljetka kao za tvrde metale
- C – izbijanje nije potrebno zbog karbidnog stupa pozicioniranog tako da obrađuje kompletan promjer bušenja

Prednosti za profesionalnu upotrebu

- Ekstremno jaka i glatka spirala rješava problem prašine
- Udarna snaga se prenosi na alat bez ikakvih gubitaka
- Smanjenje vibracije
- Dugi vijek trajanja

Prihvat



Kataloški broj	Naziv artikla	Dimenzija (promjer)	J.mj.	VPC/Kn	MPC/Kn	Narudžba / kom
A1.269.550.550	SDS Max Probojno svrdlo	269/55,0x410x550 mm	kom	1.397,50 kn	1.746,87 kn	
A1.269.550.990	SDS Max Probojno svrdlo	269/55,0x850x990 mm	kom	1.659,20 kn	2.074,00 kn	
A1.269.650.550	SDS Max Probojno svrdlo	269/65,0x410x550 mm	kom	1.509,00 kn	1,886,25 kn	
A1.269.650.990	SDS Max Probojno svrdlo	269/65,0x850x990 mm	kom	1.711,00 kn	2.138,75 kn	
A1.269.800.550	SDS Max Probojno svrdlo	269/80,0x410x550 mm	kom	1.640,00 kn	2.050,00 kn	
A1.269.800.990	SDS Max Probojno svrdlo	269/80,0x850x990 mm	kom	2.100,30 kn	2.625,37 kn	